

STS 160

FOR HEAVY DUTY FLOORS

MIGUTRANS

HEAVY-DUTY ALL-METAL JOINT SOLUTIONS FOR LARGE TRAFFIC LOADS

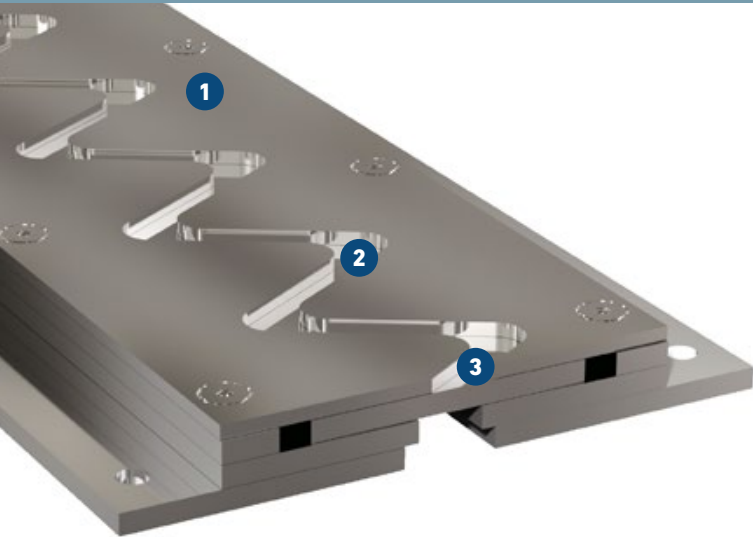

- 1 Steel-/Stainless steel-Combination**
for highest load capacity by pallet trucks, fork lift trucks, heavy lorries, special vehicles, etc.
- 2 Transportation free from vibration from a wheel width of 100 mm**
suitable for transport of sensitive goods
- 3 Absorbs horizontal movement (transverse and parallel)**
Not suitable for vertical movement

Expansion joint cover	Joint width max. b_f [mm]	Total movement Δb_f [mm]	Visible width b_s [mm]	Joint width total b_t [mm]	Joint height h [mm]	Load bearing capacity [kN]	Load bearing capacity [kN]	Load bearing capacity solid plastic tyres [kg/mm]
STS 160/30 ES	60	40 (± 20)	163	233	29	600	150	75
STS 160/45 ES	60	40 (± 20)	163	233	44	600	150	75
STS 160/60 ES	60	40 (± 20)	163	233	59	600	150	75

Production length: 1,96 m

Material - Visible surface: stainless steel 304 or 316Ti **Underlying construction:** black steel, galvanized steel or stainless steel (please specify while ordering).

Larger joint width or movement capacity or special heights on request.

Mounting distance: 300 mm

